

Operations and Troubleshooting

INDICATOR	SIREN	MEANING
Alarm sounds and the red LED is blinking rapidly.	Smoke has activated the smoke alarm.	Vacate the building and call the fire brigade (see 'What to do if Alarm Sounds').
Green LED ON.	240V mains power ON.	Normal operating condition.
Green LED OFF. Mains power may be disconnected.	240V mains power OFF.	Check mains power ON. Main circuit breaker may have tripped. Wiring could be reversed.
Red LED flashes every 40 to 60 seconds.	Red LED indicates the smoke alarm is functioning correctly.	Normal operating condition.
Red LED not flashing.	Battery may be reversed. No battery present. Battery completely flat.	Reinstall battery around the correct way or replace battery.
Audible beep is heard once every minute.	Low battery indicator is warning the battery needs replacing.	Replace 9V battery with a specified new battery.
When Test / Hush button is pressed for three seconds alarm sounds briefly.	The smoke alarm horn is indicating all electronic circuitry, horn and battery are working.	Normal test condition. Test weekly to ensure proper operation.
When Test / Hush button is pressed for three seconds alarm does not sound.	Check green LED is ON and red LED is flashing once every 40 to 60 seconds.	Turn mains power back ON and replace battery. If smoke alarm still won't Test, replace.
Smoke alarm is sounding you press the Test / Hush button and it stops.	Hush feature has been activated for 10 minutes providing the smoke density does not increase.	Normal condition. Clear the smoke as soon as you can.
Smoke alarm is sounding and you press the Test / Hush button and nothing happens.	Smoke density is too high for the Hush feature to activate.	Vacate the building and call the fire brigade. (see 'What to do if Alarm Sounds').
Smoke alarm body will not close on the base.	9V battery not present.	Install a 9V battery.
Red LED is off and alarm is sounding.	Smoke has activated an interconnected alarm, located somewhere else in the building.	Vacate the building and call fire brigade. In the event of a false alarm (use caution), locate the source of the alarm. This unit will have its alarm sounding and red LED blinking rapidly.

Maintenance, Repairs and Service

Maintenance: It is recommended that the smoke alarm is inspected monthly to ensure it is free from dirt, dust and insects. The alarm can be vacuumed or brushed with a soft brush to remove dust, dirt or kitchen grease that has accumulated. A small amount of surface spray around the alarm should deter insect ingress.

ALWAYS TEST THE SMOKE ALARM AFTER CLEANING.

Repairs / Service: The smoke alarm uses a very small amount of radioactive element, which is safely contained within the chamber assembly. If the smoke alarm is defective in any way, do not tamper with the unit. If the warranty period has expired then dispose of the unit as indicated below. Unit does not contain any user serviceable parts except the battery. DO NOT, UNDER ANY CIRCUMSTANCES, TAMPER WITH THE SEALED RADIOACTIVE SOURCE.

Disposal: Please contact local authorities for advice. Some states permit disposal in household rubbish collection. Alternative disposal might not be permitted – contact local authorities for advice.

Limited 5 Year Warranty

Clipsal Australia Pty Ltd warrants your product to be free from defects in material and workmanship for a period of five years from the date of purchase. The warranty applies only to the original consumer purchaser and only to products used in normal use and service. If this product is found to be defective, Clipsal Australia's only obligation, and your exclusive remedy, is the repair or replacement of the product, at Clipsal Australia's discretion, provided that the product has not been damaged through misuse, abuse, accident, modifications, alteration, neglect or mishandling (excluding any labour cost relating to removal or reinstallation of product and transport cost). This warranty shall not apply to any product, which is found to be improperly installed, setup or used in any way not in accordance with the instructions supplied with the product. This warranty shall not apply to any batteries used in the product or to any damage caused by such batteries. If your product fails to operate satisfactorily, please return it to the point of purchase or Clipsal Australia Pty Ltd.

CLIPSAL AUSTRALIA PTY LTD DOES NOT WARRANT AND SPECIFICALLY DISCLAIMS ANY WARRANTY, WHETHER EXPRESSED OR IMPLIED, OF FITNESS FOR A PARTICULAR PURPOSE OTHER THAN THE WARRANTY CONTAINED HEREIN. NOT IMPLIED WARRANTY ON THIS PRODUCT, CREATED BY STATE LAW, SHALL EXTEND BEYOND THE TERM OF THIS WARRANTY UNLESS SUCH LAW OTHERWISE PROVIDES. CLIPSAL AUSTRALIA PTY LTD SPECIFICALLY DISCLAIMS ANY LIABILITY AND SHALL NOT BE LIABLE FOR ANY CONSEQUENTIAL OR INCIDENTAL LOSS OR DAMAGE, INCLUDING, BUT NOT LIMITED TO, DAMAGES TO ANY EQUIPMENT WITH WHICH THIS PRODUCT IS USED.

No agent, representative, dealer or employee of the company has the authority to increase or alter the obligations or terms of this warranty. Clipsal Australia Pty Ltd reserves the right to change specifications or designs described in this manual without notice and without obligation.

This smoke alarm complies with:
AS3786
AS/NZS3100
Australian Electrical Authority
Certificate of Suitability CS/1245/S

THIS DEVICE CONTAINS
A SMALL QUANTITY OF
RADIOACTIVE MATERIAL



CLIPSAL
by Schneider Electric

Head Office
33-37 Port Wakefield Road
Gepps Cross South Australia 5094
Email: help@pdl.com.au
Website: pdl.com.au

National Customer Care Enquiries
1300 2025 25
National Customer Care Facsimile
1300 2025 56



New Zealand & International Enquiries
Schneider Electric (NZ) Ltd
PO Box 15355 New Lynn, Waitakere 0640
Auckland New Zealand
Freephone 0800 652 999
Telephone +64 9 829 0490
Facsimile +64 9 829 0491
Freefax 0800 101 152

Schneider Electric reserves the right to change specifications, modify designs and discontinue items without incurring obligation and whilst every effort is made to ensure that descriptions, specifications and other information in this catalogue are correct, no warranty is given in respect thereof and the company shall not be liable for any error therein.

© Schneider Electric

This material is copyright under Australian and international laws. Except as permitted under the relevant law, no part of this work may be reproduced by any process without prior written permission of and acknowledgement to Schneider Electric.

Schneider Electric acknowledges that the Australian Standard Certified Product logo is a trademark of SAI Global, and that the ActivFire Certified logo is a trademark of CSIRO.

FIRETEK® SMOKE ALARM 755SMA

240V a.c. Mains Power Ionisation Smoke Alarm with 9V d.c. Battery Backup

PLEASE LEAVE THESE INSTRUCTIONS WITH THE HOME OWNER, TO BE RETAINED FOR THE LIFE OF THE ALARM.
THIS SMOKE ALARM REQUIRES INSTALLATION BY A LICENSED ELECTRICAL CONTRACTOR.

CLIPSAL

by Schneider Electric

Read All Instructions Before Installation and Operation

Regular testing of this smoke alarm is necessary to ensure the unit is functional and that the battery is in good condition. We recommend the smoke alarm be replaced after 10 years of normal service. The smoke alarm uses an extremely small amount of radioactive material in the ionisation chamber. DO NOT try to open or repair the smoke alarm yourself. No user serviceable parts are inside.

Specifications

Main Power Source	220-240V a.c. 50Hz	Terminal Provisions	Active, Neutral, Loop and Interconnect terminals each accommodates 2 x 1.5mm ²
Secondary Power Source	9V d.c. carbon zinc or alkaline battery	Horn Level	85dB at three metres minimum
Operating Current	35mA	Visual Indicators	Green LED for mains power ON Red LED for warning and low battery indication
Battery Life	One year approximately	Approvals	ActivFire Certified
Sensing Type	Ionisation. Americium 241 1kBq (one microcurie)	Complies with	AS3786:1993 AS/NZS 3100:2002
Operating Temperature	5°C to 45°C	Certificate of Suitability	CS/1245/S
Ambient Humidity	10% to 90%		
Interconnecting	40 alarms over 150 metres maximum		

Information on Smoke Alarms

WHAT SMOKE ALARMS CAN DO

Smoke alarms can only HELP protect your family and home against loss from a fire. For maximum protection install smoke alarms in every bedroom, and every other area of the home, making sure the people in the home will be able to hear and respond to the alarm sound. WARNING – Smoke alarms may give you a warning of fire and smoke but only if you install, use and maintain them as recommended in this instruction leaflet.

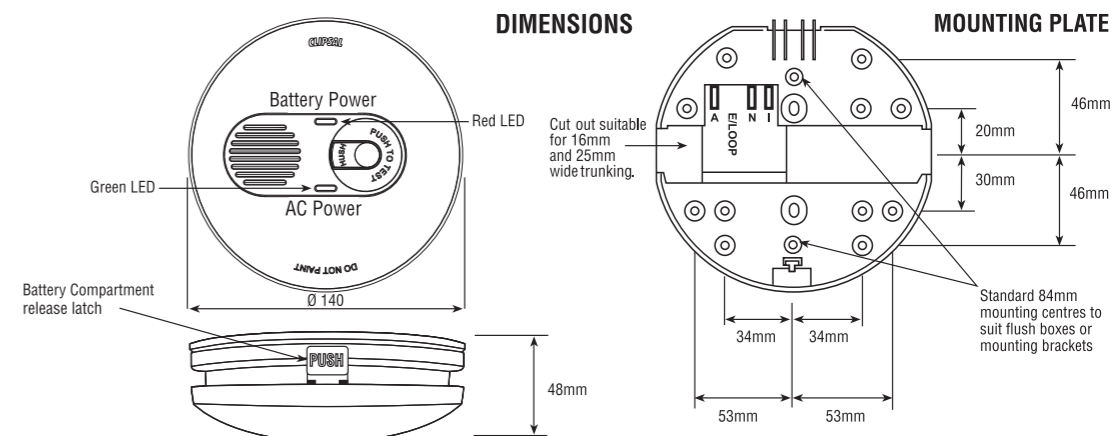

WHAT SMOKE ALARMS WILL NOT DO

A smoke alarm will not work without power – Your smoke alarm needs mains power (220-240V) and a good battery (9V) that is installed correctly to operate.

A smoke alarm will not sense a fire when smoke cannot reach the unit – If a fire starts in a chimney, wall, roof, the other side of a closed door or any other isolated area, the smoke alarm may not sense the smoke and may not give a warning. If you do not have a smoke alarm in the bedroom and sleep with the door closed, a fire inside the bedroom may not sound an alarm located in another room. Therefore it is recommended that a smoke alarm be installed inside and outside all bedrooms. A smoke alarm will not promptly sense a fire except in the area in which the smoke alarm is installed.

All types of smoke alarms have limitations – No type of smoke alarm can sense every kind of fire or smoke every time.

CHOOSING YOUR SMOKE ALARM

Fire types – A photoelectric alarm like the Clipsal 755PSMA responds faster to large smoke particles, while an ionisation alarm like the Clipsal 755SMA (this unit) responds faster to smaller smoke particles. Smouldering fires produce more large particles, so this type of fire will be more quickly detected by the 755PSMA photoelectric alarm. Flaming fires produce more small smoke particles and this type of fire will be more quickly detected by an ionisation alarm like the 755SMA. The type of fire likely in a location is therefore an important consideration when choosing which type of smoke alarm to install.

How an ionisation alarm Works – An ionisation detector uses a small amount of a radioactive source for correct operation and emitting alpha particles (positively charged particles) onto an electrode. In turn a small current is established in the sensing chamber. Upon entering the sensing chamber, smoke particles change the electrical conductivity within the chamber. When the electrical conductivity reaches a predetermined threshold, the unit goes into alarm mode and the horn will sound to alert occupants.

Nuisance alarms – Because an ionisation type alarm is sensitive to small smoke particles, it will respond more quickly to particles typically given off during cooking, even where there may be no danger. On the basis of this "nuisance" alarming, consideration should be given to installing photoelectric alarms like the 755PSMA in kitchen areas. While the home owner will lose some warning time in a fire that generates smaller smoke particles, they will also reduce the occurrence of the one nuisance that results in a lot of smoke alarms being disabled.

Using a smoke alarm in a smokey area like a kitchen or in a high humidity area such as a bathroom can cause false alarms. Do not remove the battery to quieten the alarm, or take the alarm down. A smoke alarm will not protect you if it is not powered or if it is not there.

A smoke alarm may not always warn you about fires caused by the following:

- Smoking in bed
- Children playing with matches or lighters
- Incorrect storage of flammable materials
- Over-loaded electrical circuits.

So please remain vigilant against fire risks at all times. Fire prevention is your best safeguard.

Recommended Location of Alarms

- Locate the first alarm in the immediate areas of the bedrooms. Try to protect the exit path as the bedrooms are usually furthest from an exit. If more than one sleeping area exists, locate additional alarms in each sleeping area.
- Locate additional alarms to protect any stairway as stairways act like chimneys for smoke and heat.
- Locate at least one alarm on every floor level.
- Locate an alarm in any area where a smoker sleeps or where electrical appliances are operated in sleeping areas.
- Smoke, heat and other combustion products rise to the ceiling and spread horizontally. Mounting the detector on the ceiling in the centre of the room places it closest to all points in the room. Ceiling mounting is preferred in ordinary residential construction. However, in mobile homes, wall mounting on an inside partition is required to avoid the thermal barrier that may form at the ceiling.
- When mounting alarm in the ceiling, locate it a minimum of 30cm from a side wall and 30cm from any corner (see Diagram A).
- When mounting alarm on a wall, use an inside wall with the alarm a maximum of 50cm below the ceiling and at least 30cm from any corner (see Diagram A).

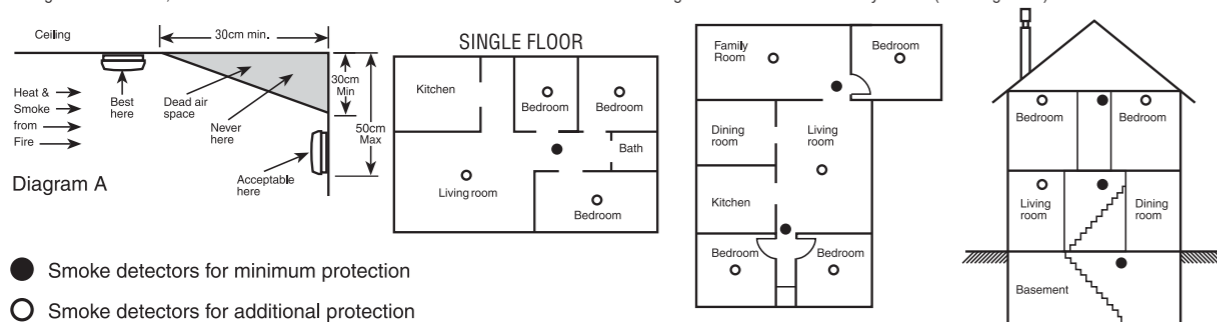

Avoid These Locations

- Do not install a smoke alarm within one metre of heating and cooling supply vents or within one metre of return air or fresh air vents. Smoke may be blown away from the smoke alarm by the supply vents, or could be diffused or reduced by being diverted into the return air vent.
- Do not install your smoke alarm in an area where the temperature may fall below 5°C or rise above 45°C. Smoke alarms are designed to work safely only within these temperature ranges and failure to alarm, improper alarms or nuisance alarms may result from operation outside these temperature limits.
- Do not install a smoke alarm in a damp or very humid area such as bathrooms with showers, where the normal humidity may rise above 90%. Above this level, moisture may condense inside the smoke chamber and cause wrong or false alarms. The smoke alarm may also become unstable below 10% relative humidity.
- Do not install a smoke alarm in an area where particles of combustion are normally present, such as garages or kitchens etc. as this can cause false alarms.
- Do not install a smoke alarm in dusty or dirty areas – such an installation cannot be relied on. An accumulation of dust and dirt in the sensing chamber may block the openings and prevent an alarm, or may get inside the alarm and cause false alarms. If a smoke alarm is required in such an area, vacuum it frequently and test it according to the 'Operation and Testing' section.
- Do not install a smoke alarm in the dead air space in the corner where the wall meets the ceiling. If in doubt as to the exact location of mounting, for your safety, contact your local fire department for help choosing a location.
- Do not install a smoke alarm where bugs or insects are present before eliminating or minimising the problem. Although all smoke alarms built since 1985 are made to prevent bugs from entering the detection chamber, bugs may build up on chamber openings and prevent smoke from entering. If bugs are present, vacuum the unit frequently as described in the maintenance section.
- Do not install a smoke alarm within one metre of a fluorescent or compact fluorescent lamp. Electrical 'noise' may cause nuisance alarms.

Installation

CAUTION: The smoke alarm will function correctly either as a stand-alone alarm or interconnected. All interconnected smoke alarms must be supplied from a single power circuit. A common Neutral must be used for the Interconnect to function. Do not connect the Interconnect wire to Active or Neutral.

WIRING: All 220-240V wiring must comply with AS/NZS3000 wiring rules.

1. Strip the Active, Neutral and Interconnect (if used) wires back to the strip length shown.
2. Connect the wires to the correct terminals on the base as indicated and ensure the screws are fully tightened.
3. Clip the flap closed preventing accidental contact with the live terminals.
4. Screw the mounting base on the ceiling or wall using the screws provided.
5. Clip the smoke alarm on to the base and install the 9V battery. The smoke alarm base will only close with a battery installed.

Note: Do not close unless a battery is installed.

6. Turn on the mains power and check the green and red LED's function. Green LED should glow to show mains power present. Red LED will pulse every 40-60 seconds to indicate correct operation and the 9V battery is OK.
7. Press the Test / Hush button to check the alarm works.

DO NOT LEAVE THE INSTALLATION UNTIL THE RED AND GREEN LEDS AND THE ALARM HAVE BEEN CHECKED FOR CORRECT OPERATION.

Use minimum of 1mm² 250V insulated wire for all wiring including Interconnecting.

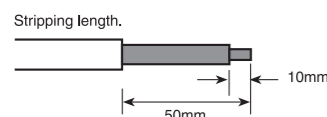

Terminal
A - Active/Line
I - Interconnect
N - Neutral
E/Loop - Earth or Loop

220-240V a.c.
1mm² minimum

Black Neutral (N)
Red Active (A)

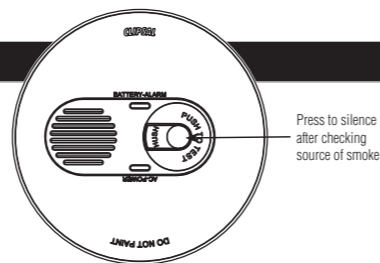

Hush or Silence Feature

- This smoke alarm has a built in "Hush" or "Silence" feature incorporated into the Test button.
- If cooking or other non-hazardous sources cause the alarm to sound it can be temporarily silenced by pressing the Test / Hush button for three seconds.
- The alarm then enters a dormant period for 10 minutes.
- If the smoke density increases during this period (i.e. from a fire) the unit will go into alarm mode.
- After the 10 minute dormant period the smoke alarm resumes normal operation and two beeps will sound to indicate this.

Interconnecting Smoke Alarms

HOW INTERCONNECTED ALARMS FUNCTION

- Interconnecting smoke alarms is a method of joining a series of alarms so that if any one alarm senses smoke, all the alarms in the series will operate (alarm).
- 9V signal on the I and N wires is used to alarm all the other interconnected alarms.
- A combination of Clipsal 755 Series Ionisation or Photoelectric smoke alarms can be used on one circuit.

WARNING

- All interconnected smoke alarms must be supplied from a single power circuit.
- A common Neutral must be used for the Interconnect to function.
- DO NOT connect the Interconnect wire to Active or Neutral.
- A maximum of 40 Clipsal 755 Series smoke alarms can be installed on one circuit.

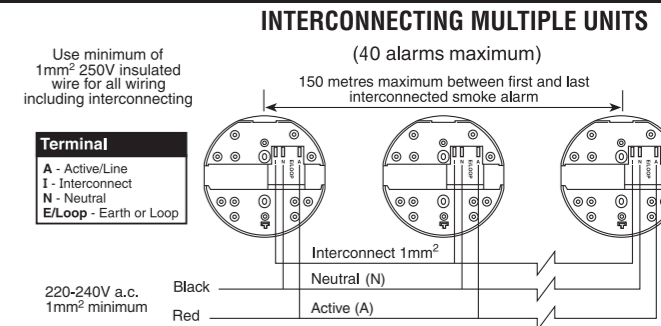

Develop and Practise a Plan of Escape

BASICS OF ESCAPE PLAN

- Make a floor plan indicating all doors and windows and at least two escape routes from each room. Second storey windows may need a rope or chain ladder.
- Have a family meeting and discuss your escape plan, showing everyone what to do in case of fire.
- Determine a place outside your home where all of you can meet if a fire occurs i.e. letterbox.
- Familiarise everyone with the sound of the smoke alarm and train them to leave your home when they hear that sound.
- Identify children's bedrooms with red stickers placed in the upper left corner of the windows.
- Practise a fire drill at least every six months. Practice allows you to test your plan before an emergency.

You may not be able to reach your children.

It is important they know what to do!



What to do if Alarm Sounds

- Leave immediately by following your escape plan. Every second counts so don't waste time getting dressed or picking up valuables.
- In leaving, don't open any inside door without first feeling its surface. If hot, or if you see smoke seeping through cracks, don't open that door! Instead, use an alternative exit. If inside door is cool, place your shoulder against it, open it slightly and be ready to slam it shut if heat and smoke rushes in.
- Stay close to the floor if air is smokey. Breathe shallowly through a cloth, wet if possible.
- Once outside, go to your selected meeting place and make sure everyone is there.
- Call the fire brigade from your neighbour's home – not from yours!
- Don't return to your home until fire officials say that it is all right to do so.

Most Importantly...
DON'T PANIC!

Operation and Testing

Operation

Operation
Once the mains power (220-240V) is connected and the 9V battery is present the smoke alarm is operating.

Operation Once Smoke Is Detected

The smoke alarm will sound a loud alarm (85dB) and the Red LED will flash rapidly. This will continue until the air is cleared.

Standby Condition

The red LED flashes once every 40-60 seconds to indicate the smoke alarm and battery are functioning correctly.

Green LED

The green LED glows when the mains power (220-240V) is on.

Testing

TEST THE SMOKE ALARM ONCE PER MONTH TO ENSURE PROPER OPERATION

Test by pushing the Test / Hush button on the smoke alarm for three seconds until the alarm sounds. The alarm sounds if all electronic circuitry, horn and battery are working. If no alarm sounds check the battery is installed the correct way around or replace the battery. If the battery is new and installed correctly and the alarm still doesn't sound replace the smoke alarm. If the smoke alarm is installed in a mobile home, test weekly and after every journey.

IMPORTANT - If premises is unoccupied for a period of time (more than a few days) then battery test should be undertaken on return. If the low battery warning sounds, test and replace battery if necessary.

- **Caution: Never use an open flame of any type to test your alarm.**
- **Check all interconnected smoke alarms operate during the test.**

Replacing the Backup Battery

The secondary backup power for the smoke alarm is supplied by a 9V carbon zinc or alkaline battery. The battery should last at least one year under normal operating conditions.

IT IS RECOMMENDED YOU REPLACE THE BATTERY ON A DAY YOU CAN REMEMBER EVERY YEAR i.e. birthday, daylight saving.

Test unit once per month
Replace battery once per year
Replace unit every ten years

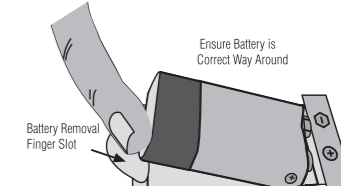
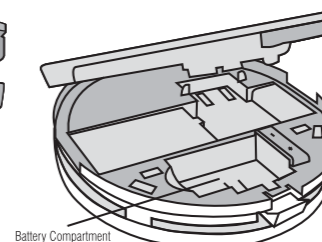
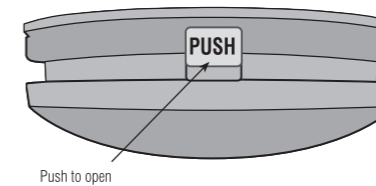

The smoke alarm has a low battery audible beep. If the smoke detector sounds a 'beep' once a minute replace the battery with a new one.

Use only recommended batteries that are readily available at local supermarkets or hardware stores.

Recommended Batteries - Energizer 522, Duracell MN1604, Eveready A522 or 1222